 vorläufige Daten
 preliminary data

Höchstzulässige Werte / maximum rated values

Elektrische Eigenschaften / electrical properties

Kollektor Emitter Sperrspannung collector emitter voltage		V_{CES}	1200	V
Kollektor Dauergleichstrom DC collector current	$T_c = 80^\circ\text{C}$	$I_{C, \text{nom}}$	75	A
	$T_c = 25^\circ\text{C}$	I_C	100	A
Periodischer Kollektor Spitzenstrom repetitive peak collector current	$t_p = 1\text{ms}, T_c = 80^\circ\text{C}$	I_{CRM}	150	A
Gesamt Verlustleistung total power dissipation	$T_c = 25^\circ\text{C}$	P_{tot}	350	W
Gate Emitter Spitzenspannung gate emitter peak voltage		V_{GES}	+/- 20	V
Dauergleichstrom DC forward current		I_F	75	A
Periodischer Spitzenstrom repetitive peak forward current	$t_p = 1\text{ms}$	I_{FRM}	150	A
Grenzlastintegral I^2t value	$V_R = 0\text{V}, t_p = 10\text{ms}, T_{vj} = 125^\circ\text{C}$	I^2t	1,19	kA ² s
Isolations Prüfspannung insulation test voltage	RMS, $f = 50\text{Hz}, t = 1\text{min}$	V_{ISOL}	2,5	kV

Charakteristische Werte / characteristic values

Transistor Wechselrichter / transistor inverter

			min.	typ.	max.	
Kollektor Emitter Sättigungsspannung collector emitter saturation voltage	$V_{GE} = 15\text{V}, T_{vj} = 25^\circ\text{C}, I_C = I_{C, \text{nom}}$	V_{CESat}	-	1,7	2,1	V
	$V_{GE} = 15\text{V}, T_{vj} = 125^\circ\text{C}, I_C = I_{C, \text{nom}}$		-	2	t.b.d.	V
Gate Schwellenspannung gate threshold voltage	$V_{CE} = V_{GE}, T_{vj} = 25^\circ\text{C}, I_C = 3\text{mA}$	$V_{GE(th)}$	5	5,8	6,5	V
Gateladung gate charge	$V_{GE} = -15\text{V} \dots +15\text{V}$	Q_G	-	0,7	-	μC
Eingangskapazität input capacitance	$f = 1\text{MHz}, T_{vj} = 25^\circ\text{C}, V_{CE} = 25\text{V}, V_{GE} = 0\text{V}$	C_{ies}	-	5,3	-	nF
Rückwirkungskapazität reverse transfer capacitance	$f = 1\text{MHz}, T_{vj} = 25^\circ\text{C}, V_{CE} = 25\text{V}, V_{GE} = 0\text{V}$	C_{res}	-	0,2	-	nF
Kollektor Emitter Reststrom collector emitter cut off current	$V_{CE} = 1200\text{V}, V_{GE} = 0\text{V}, T_{vj} = 25^\circ\text{C}$	I_{CES}	-	-	5	mA
Gate Emitter Reststrom gate emitter leakage current	$V_{CE} = 0\text{V}, V_{GE} = 20\text{V}, T_{vj} = 25^\circ\text{C}$	I_{GES}	-	-	400	nA

prepared by: Mark Münzer	date of publication: 2001-08-16
approved: Martin Hierholzer	revision: 2



vorläufige Daten
preliminary data

Charakteristische Werte / characteristic values

Transistor Wechselrichter / transistor inverter

			min.	typ.	max.	
Einschaltverzögerungszeit (induktive Last) turn on delay time (inductive load)	$I_C = I_{C, \text{nom}}, V_{CC} = 600V$	$t_{d, \text{on}}$	-	260	-	ns
	$V_{GE} = \pm 15V, R_G = 4,7\Omega, T_{vj} = 25^\circ C$			285		
Anstiegszeit (induktive Last) rise time (inductive load)	$I_C = I_{C, \text{nom}}, V_{CC} = 600V$	t_r	-	30	-	ns
	$V_{GE} = \pm 15V, R_G = 4,7\Omega, T_{vj} = 25^\circ C$			45		
Abschaltverzögerungszeit (induktive Last) turn off delay time (inductive load)	$I_C = I_{C, \text{nom}}, V_{CC} = 600V$	$t_{d, \text{off}}$	-	420	-	ns
	$V_{GE} = \pm 15V, R_G = 4,7\Omega, T_{vj} = 25^\circ C$			520		
Fallzeit (induktive Last) fall time (inductive load)	$I_C = I_{C, \text{nom}}, V_{CC} = 600V$	t_f	-	65	-	ns
	$V_{GE} = \pm 15V, R_G = 4,7\Omega, T_{vj} = 25^\circ C$			90		
Einschaltverlustenergie pro Puls turn on energy loss per pulse	$I_C = I_{C, \text{nom}}, V_{CC} = 600V, L_\sigma = 70nH$ $V_{GE} = \pm 15V, R_G = 4,7\Omega, T_{vj} = 25^\circ C$	E_{on}	-	7	-	mJ
Ausschaltverlustenergie pro Puls turn off energy loss per pulse	$I_C = I_{C, \text{nom}}, V_{CC} = 600V, L_\sigma = 70nH$ $V_{GE} = \pm 15V, R_G = 4,7\Omega, T_{vj} = 25^\circ C$	E_{off}	-	9,5	-	mJ
Kurzschlussverhalten SC data	$t_P \leq 10\mu\text{sec}, V_{GE} \leq 15V, T_{vj} \leq 125^\circ C$ $V_{CC} = 900V, V_{CE\text{max}} = V_{CES} - L_{\sigma CE} \cdot di/dt$	I_{SC}	-	300	-	A
Modulinduktivität stray inductance module		$L_{\sigma CE}$	-	21	-	nH
Leitungswiderstand, Anschluss-Chip lead resistance, terminal-chip	$T_c = 25^\circ C$	$R_{CC/EE}$	-	1,8	-	mΩ

Charakteristische Werte / characteristic values

Diode Wechselrichter / diode inverter

Durchlassspannung forward voltage	$I_F = I_{C, \text{nom}}, V_{GE} = 0V, T_{vj} = 25^\circ C$	V_F	-	1,65	2,1	V
	$I_F = I_{C, \text{nom}}, V_{GE} = 0V, T_{vj} = 125^\circ C$			1,65		
Rückstromspitze peak reverse recovery current	$I_F = I_{C, \text{nom}}, -di_F/dt = 2000A/\mu\text{s}$	I_{RM}	-	90	-	A
	$V_R = 600V, V_{GE} = -10V, T_{vj} = 25^\circ C$			100		
Sperrverzögerungsladung recovered charge	$I_F = I_{C, \text{nom}}, -di_F/dt = 2000A/\mu\text{s}$	Q_r	-	7	-	μC
	$V_R = 600V, V_{GE} = -10V, T_{vj} = 25^\circ C$			14		
Ausschaltenergie pro Puls reverse recovery energy	$I_F = I_{C, \text{nom}}, -di_F/dt = 2000A/\mu\text{s}$	E_{rec}	-	3	-	mJ
	$V_R = 600V, V_{GE} = -10V, T_{vj} = 25^\circ C$			6		

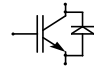

vorläufige Daten
preliminary data

Charakteristische Werte / characteristic values

NTC-Widerstand / NTC-thermistor

			min.	typ.	max.	
Nennwiderstand rated resistance	$T_c = 25^\circ\text{C}$	R_{25}	-	5	-	k Ω
Abweichung von R_{100} deviation of R_{100}	$T_c = 100^\circ\text{C}, R_{100} = 493\Omega$	$\Delta R/R$	-5	-	5	%
Verlustleistung power dissipation	$T_c = 25^\circ\text{C}$	P_{25}	-	-	20	mW
B-Wert B-value	$R_2 = R_1 \exp[B(1/T_2 - 1/T_1)]$	$B_{25/50}$	-	3375	-	K

Thermische Eigenschaften / thermal properties

Innerer Wärmewiderstand; DC thermal resistance, junction to case; DC	Transistor Wechselr. / transistor inverter	R_{thJC}	-	-	0,35	K/W
	Diode Wechselrichter / diode inverter		-	-	0,58	K/W
Übergangs Wärmewiderstand thermal resistance, case to heatsink	pro Modul / per module $\lambda_{\text{Paste}} = 1\text{W/m}^2\text{K} / \lambda_{\text{grease}} = 1\text{W/m}^2\text{K}$	R_{thCK}	-	0,009	-	K/W
Höchstzulässige Sperrschichttemp. maximum junction temperature		T_{vjmax}	-	-	150	$^\circ\text{C}$
Betriebstemperatur operation temperature		T_{vjop}	-40	-	125	$^\circ\text{C}$
Lagertemperatur storage temperature		T_{stg}	-40	-	125	$^\circ\text{C}$

Mechanische Eigenschaften / mechanical properties

Gehäuse, siehe Anlage case, see appendix						
Innere Isolation internal insulation				Al_2O_3		
CTI comperative tracking index				225		
Anzugsdrehmoment, mech. Befestigung mounting torque	Schraube M5 screw M5	M	3	-	6	Nm
Gewicht weight		G		300		g

Mit dieser technischen Information werden Halbleiterbauelemente spezifiziert, jedoch keine Eigenschaften zugesichert. Sie gilt in Verbindung mit den zugehörigen technischen Erläuterungen.

This technical information specifies semiconductor devices but promises no characteristics. It is valid with the belonging technical notes.



vorläufige Daten
preliminary data

Ausgangskennlinie (typisch)
output characteristic (typical)

$I_C = f(V_{CE})$
 $V_{GE} = 15V$

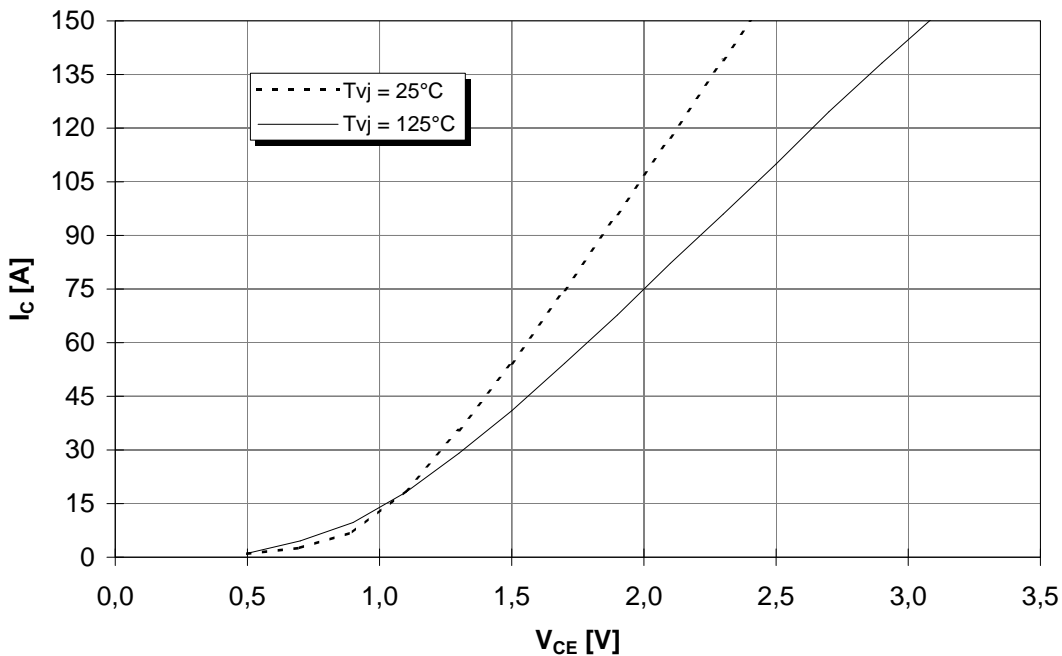

Ausgangskennlinienfeld (typisch)
output characteristic (typical)

$I_C = f(V_{CE})$
 $T_{vj} = 125^\circ C$

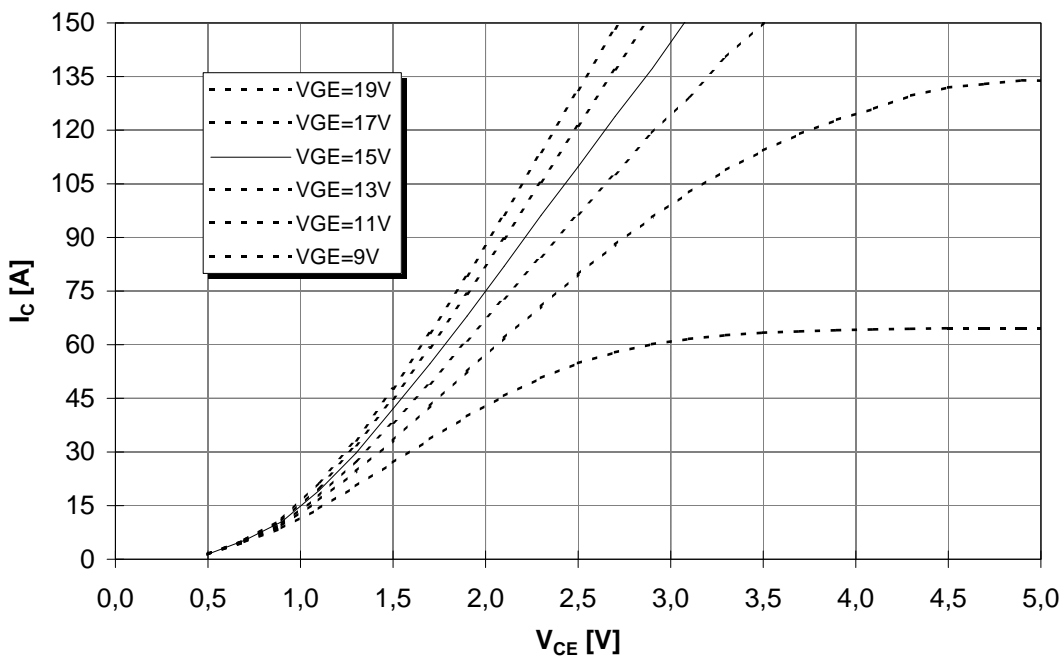



vorläufige Daten
preliminary data

Übertragungscharakteristik (typisch)
transfer characteristic (typical)

$I_C = f(V_{GE})$
 $V_{CE} = 20V$

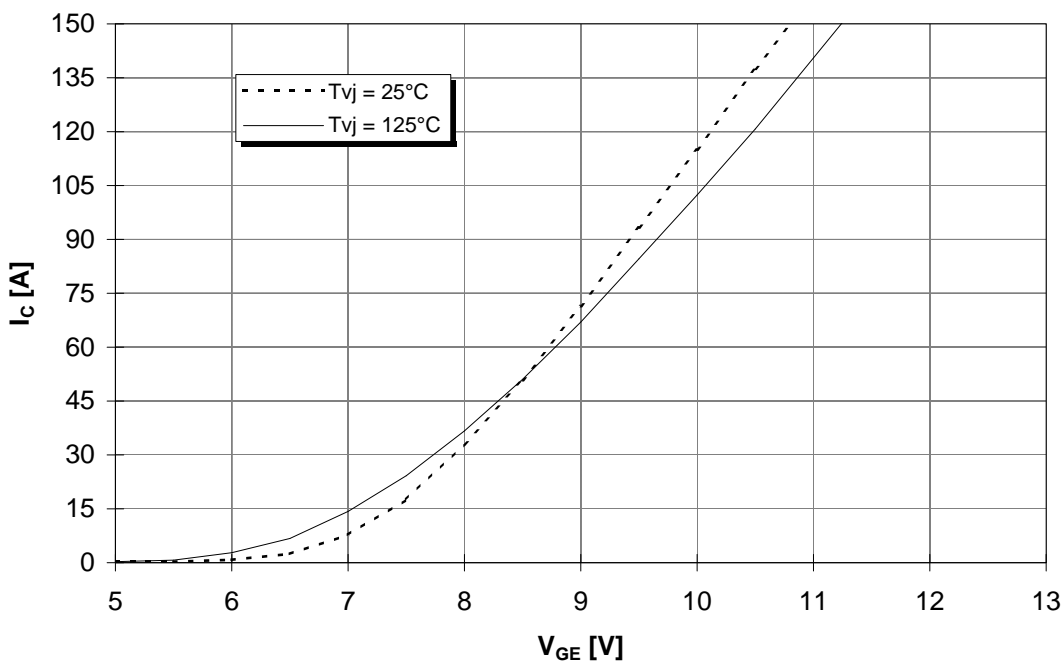

Durchlasskennlinie der Inversdiode (typisch)
forward characteristic of inverse diode (typical)

$I_F = f(V_F)$

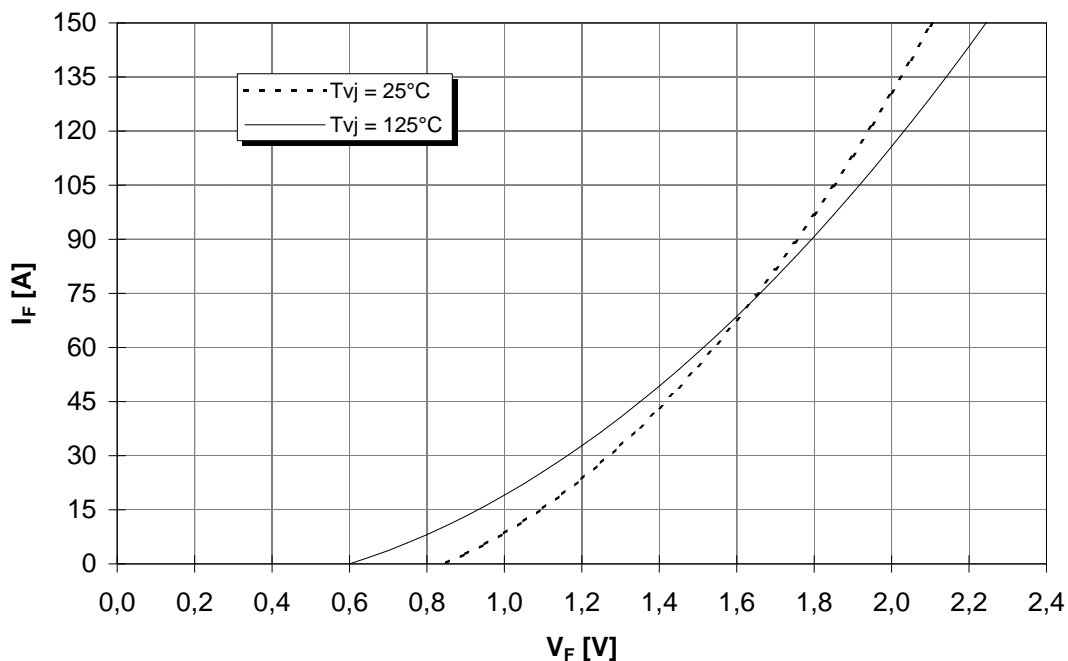



vorläufige Daten
preliminary data

Schaltverluste (typisch)
Switching losses (typical)

$E_{on} = f(I_C)$, $E_{off} = f(I_C)$, $E_{rec} = f(I_C)$
 $V_{GE}=15V$, $R_{Gon}=R_{Goff}=4,7W$, $V_{CE}=600V$, $T_I=125^\circ C$

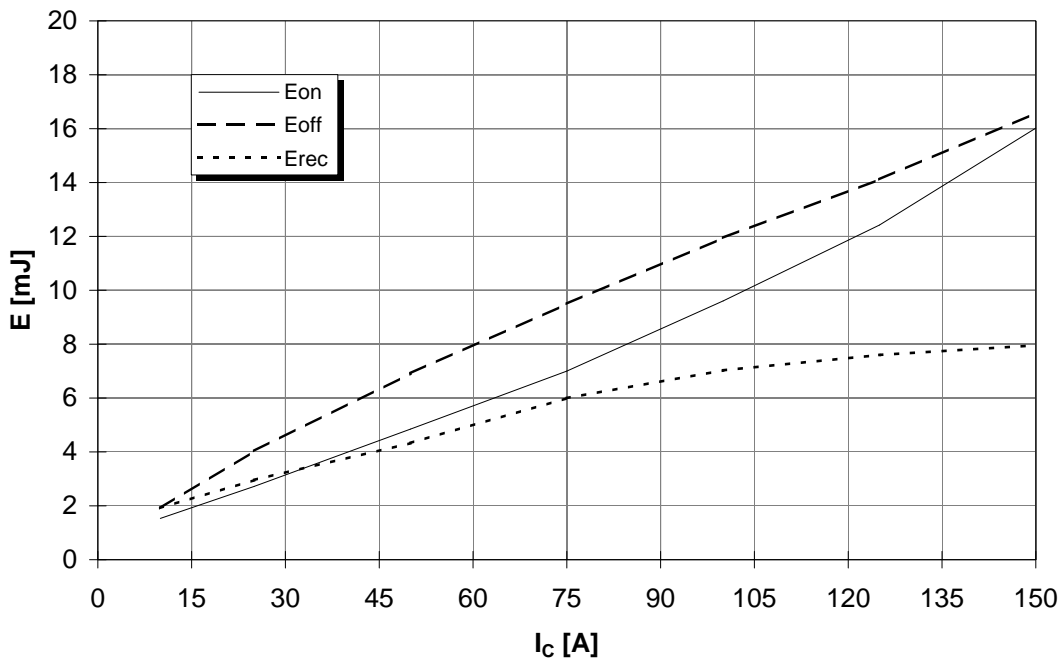

Schaltverluste (typisch)
Switching losses (typical)

$E_{on} = f(R_G)$, $E_{off} = f(R_G)$, $E_{rec} = f(R_G)$
 $V_{GE}=15V$, $I_C=75A$, $V_{CE}=600V$, $T_I=125^\circ C$

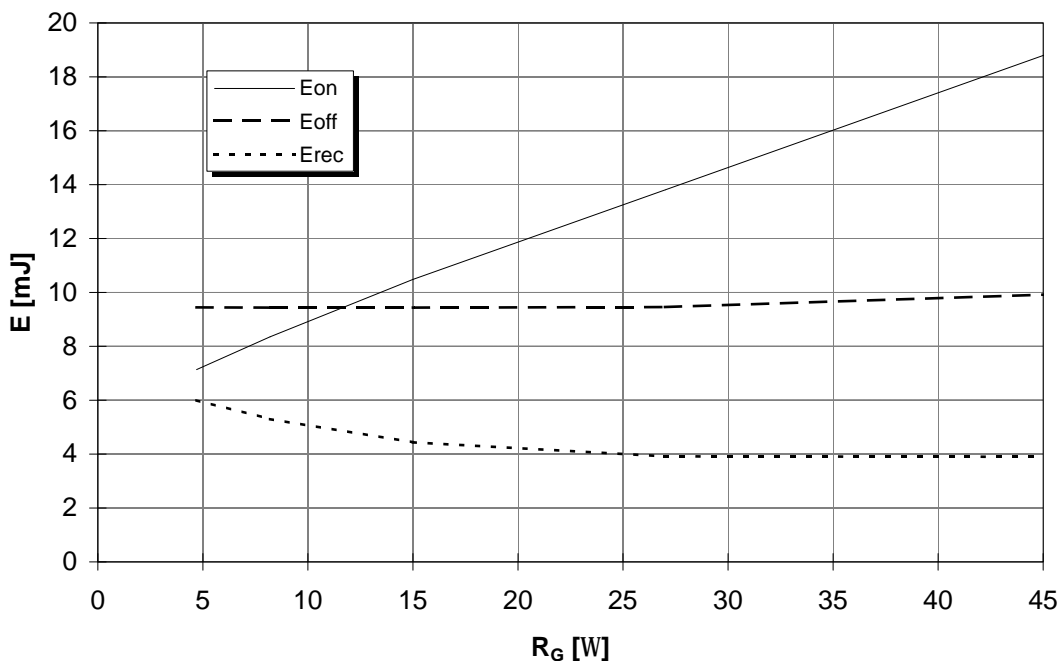

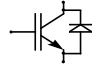

vorläufige Daten
preliminary data

Transienter Wärmewiderstand
Transient thermal impedance

$$Z_{thJC} = f(t)$$

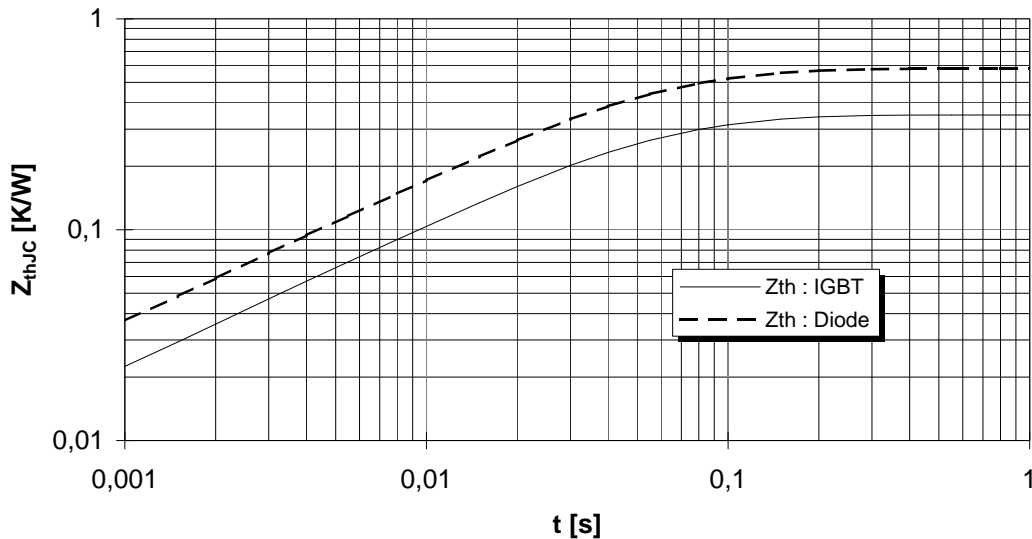

i	1	2	3	4
r_i [K/kW] : IGBT	146,98	176,19	20,20	6,63
t_i [s] : IGBT	6,499E-02	2,601E-02	2,364E-03	1,187E-05
r_i [K/kW] : Diode	243,65	292,44	32,94	10,97
t_i [s] : Diode	6,499E-02	2,601E-02	2,364E-03	1,187E-05

Sicherer Arbeitsbereich (RBSOA)
Reverse bias safe operation area (RBSOA)

$$V_{GE}=15V, T_F=125^{\circ}C$$

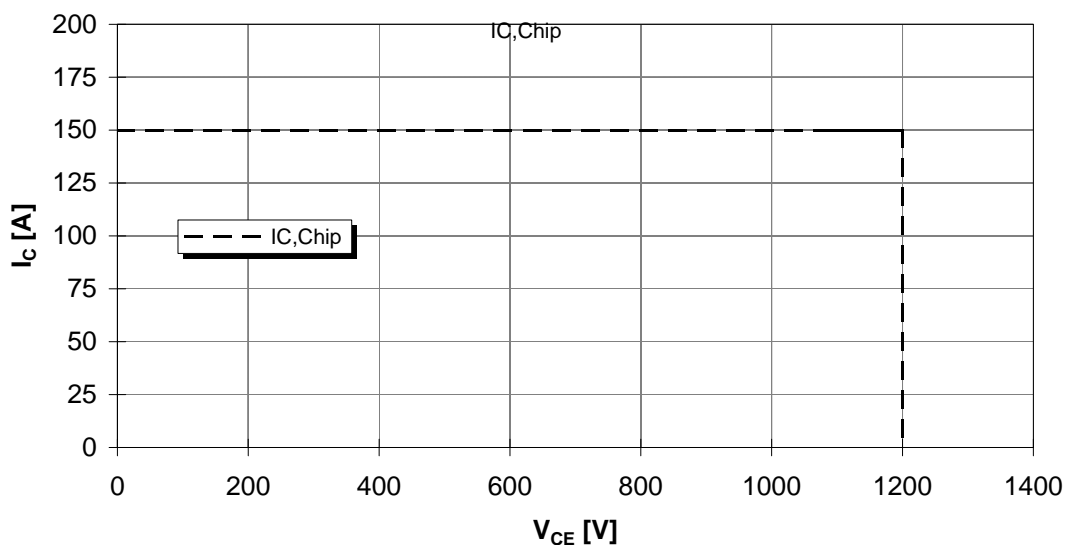

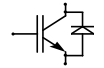

vorläufige Daten
preliminary data

Gehäusemaße / Schaltbild Package outline / Circuit diagram

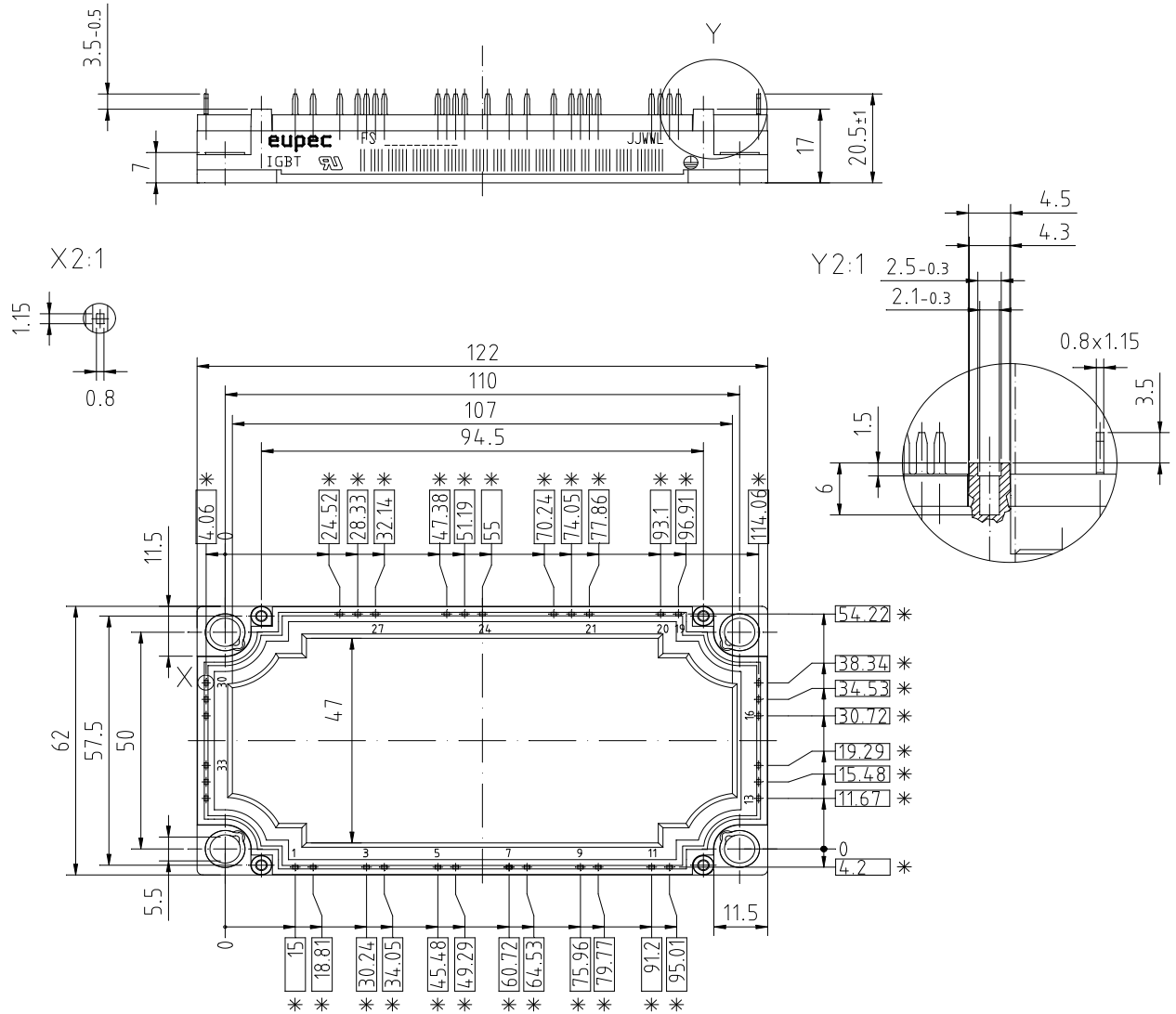

* = alle Maße mit einer Toleranz von ± 0.5

